

# BOARD & BATTEN PANEL

GREAT FOR GABLES AND WAINSCOT | USE AS HORIZONTAL SIDING  
 AVAILABLE IN 8' - 20' LENGTHS IN 2' INCREMENTS | 22 COLOR OPTIONS

BOARD AND BATTEN FLAT PANEL  
 10" COVERAGE LAPPED

← 1.840 →

OVERLAP DETAIL

BOARD AND BATTEN WITH STRIATIONS

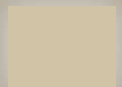

IVORY

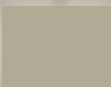

LIGHT STONE

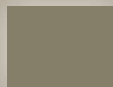

BUCKSKIN

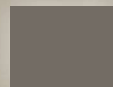

TAUPE

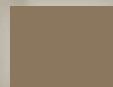

TAN

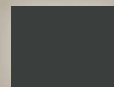

CHARCOAL



BURNISHED SLATE

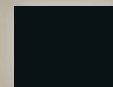

BLACK

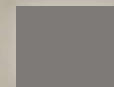

SLATE GRAY



GRAY



GALVANIZED

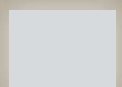

BRILLIANT WHITE



ALAMO WHITE



BRITE RED



RUSTIC RED



BURGUNDY

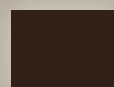

BROWN



COPPER PENNY

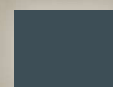

OCEAN BLUE



GALLERY BLUE



HUNTER GREEN

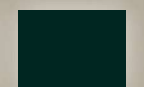

FOREST GREEN



# BOARD & BATTEN PANEL TRIMS

### OUTSIDE CORNER

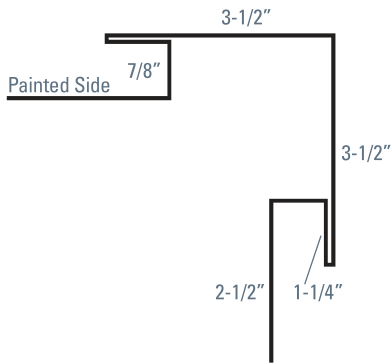

### INSIDE CORNER

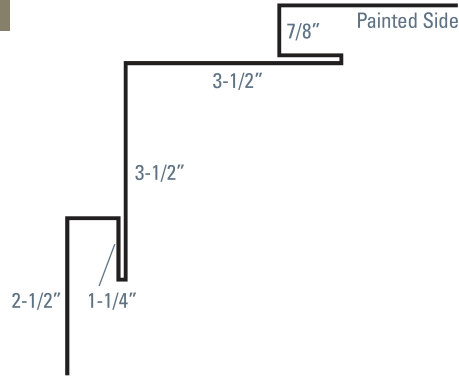

### OPEN HEM CORNER

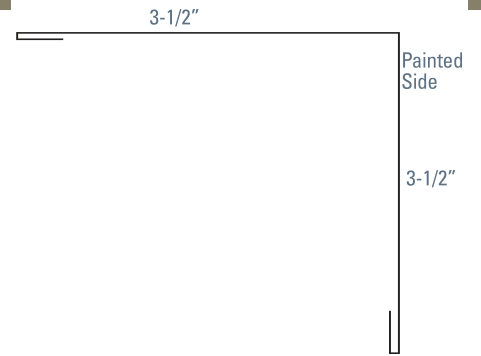

### J TRIM

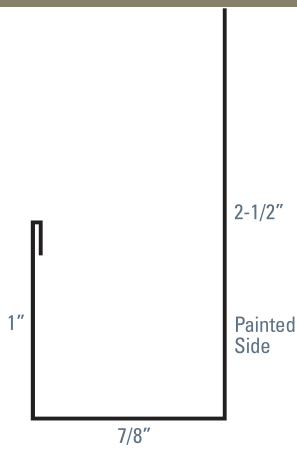

### DOUBLE ANGLE

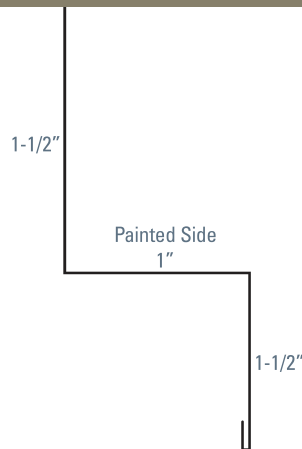

### DRIP CAP 1"

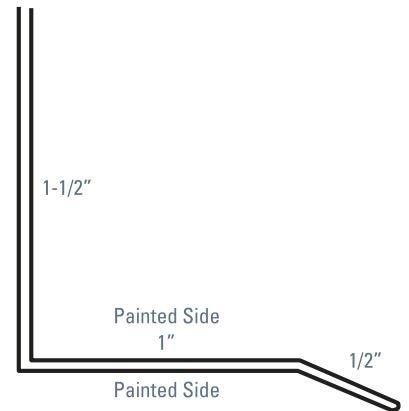

### SQUARE BASE TRIM

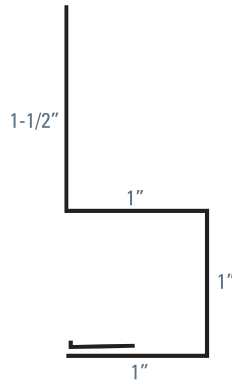

### UTILITY TRIM

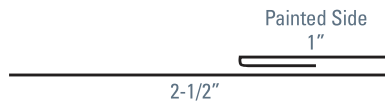

### PANEL CAP

